

Chapter 26

Capacitance and Dielectrics

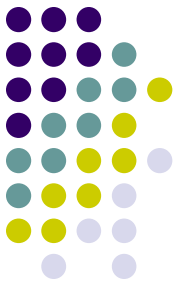



Capacitors

- Capacitors are devices that store electric charge
- Examples of where capacitors are used include:
 - radio receivers
 - filters in power supplies
 - to eliminate sparking in automobile ignition systems
 - energy-storing devices in electronic flashes



Definition of Capacitance

- **The capacitance**, C , of a capacitor is defined as the ratio of the magnitude of the charge on either conductor to the potential difference between the conductors

$$C \equiv \frac{Q}{\Delta V}$$

- The SI unit of capacitance is the **farad** (F)

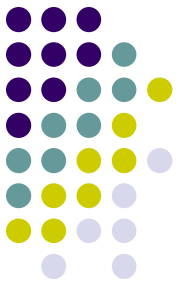

Makeup of a Capacitor

- A capacitor consists of two conductors
 - These conductors are called *plates*
 - When the conductor is charged, the plates carry charges of equal magnitude and opposite directions
- A potential difference exists between the plates due to the charge

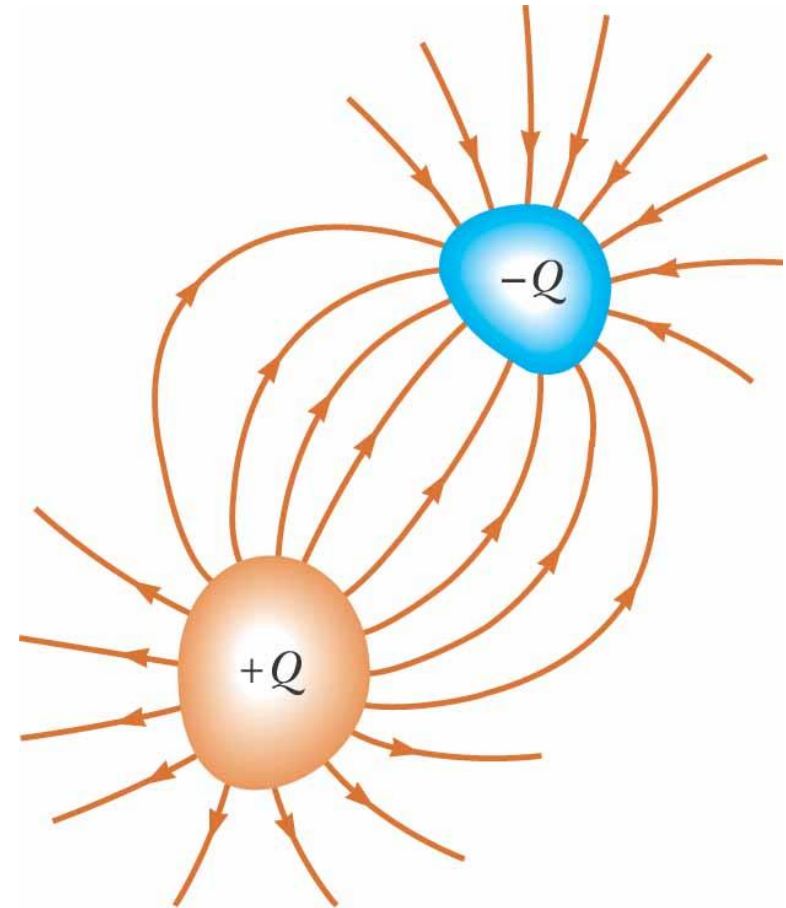

©2004 Thomson - Brooks/Cole

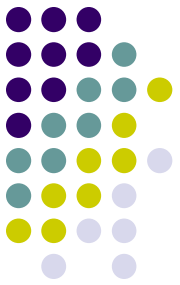

More About Capacitance

- Capacitance will always be a positive quantity
- The capacitance of a given capacitor is constant
- The capacitance is a measure of the capacitor's ability to store charge
- The farad is a large unit, typically you will see microfarads (μF) and picofarads (pF)

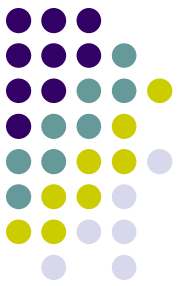

Parallel Plate Capacitor

- Each plate is connected to a terminal of the battery
 - The battery is a source of potential difference
- If the capacitor is initially uncharged, the battery establishes an electric field in the connecting wires

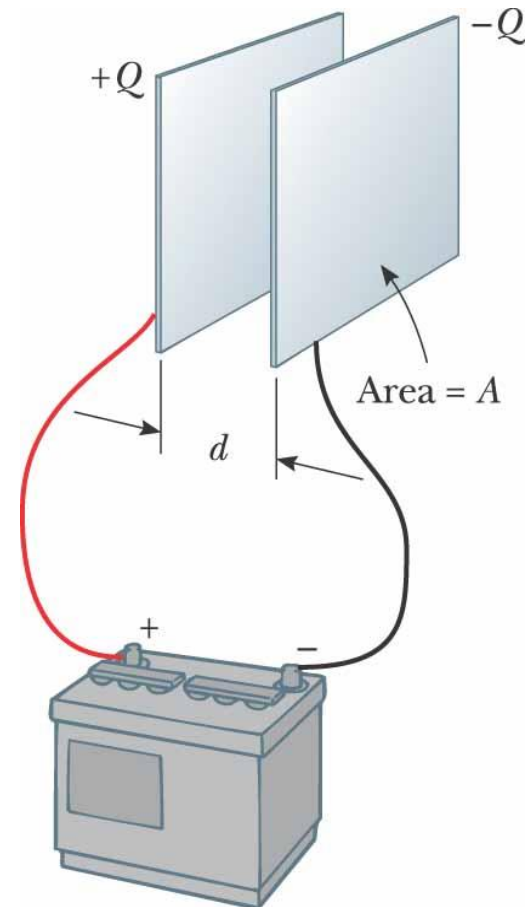

Parallel Plate Capacitor, cont



- This field applies a force on electrons in the wire just outside of the plates
- The force causes the electrons to move onto the negative plate
- This continues until equilibrium is achieved
 - The plate, the wire and the terminal are all at the same potential
- At this point, there is no field present in the wire and the movement of the electrons ceases

Parallel Plate Capacitor, final

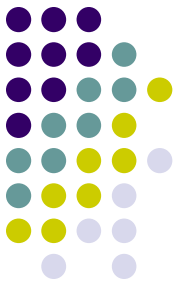

- The plate is now negatively charged
- A similar process occurs at the other plate, electrons moving away from the plate and leaving it positively charged
- In its final configuration, the potential difference across the capacitor plates is the same as that between the terminals of the battery

Capacitance – Isolated Sphere

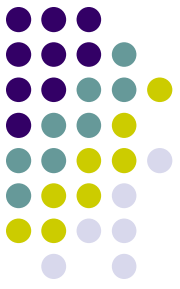

- Assume a spherical charged conductor with radius a
- The sphere will have the same capacitance as it would if there were a conducting sphere of infinite radius, concentric with the original sphere
- Assume $V = 0$ for the infinitely large shell

$$C = \frac{Q}{\Delta V} = \frac{Q}{k_e Q/a} = \frac{R}{k_e} = 4\pi\epsilon_0 a$$

- Note, this is independent of the charge and the potential difference

Capacitance – Parallel Plates

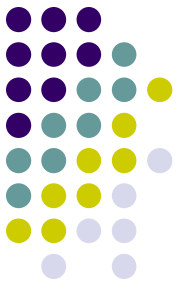

- The charge density on the plates is $\sigma = Q/A$
 - A is the area of each plate, which are equal
 - Q is the charge on each plate, equal with opposite signs
- The electric field is uniform between the plates and zero elsewhere

Capacitance – Parallel Plates, cont.



- The capacitance is proportional to the area of its plates and inversely proportional to the distance between the plates

$$C = \frac{Q}{\Delta V} = \frac{Q}{Ed} = \frac{Q}{Qd/\epsilon_0 A} = \frac{\epsilon_0 A}{d}$$

Capacitance of a Cylindrical Capacitor

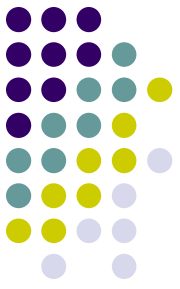

- $\Delta V = -2k_e \lambda \ln(b/a)$
- $\lambda = Q/l$
- **The capacitance is**

$$C = \frac{Q}{\Delta V} = \frac{\ell}{2k_e \ln(b/a)}$$

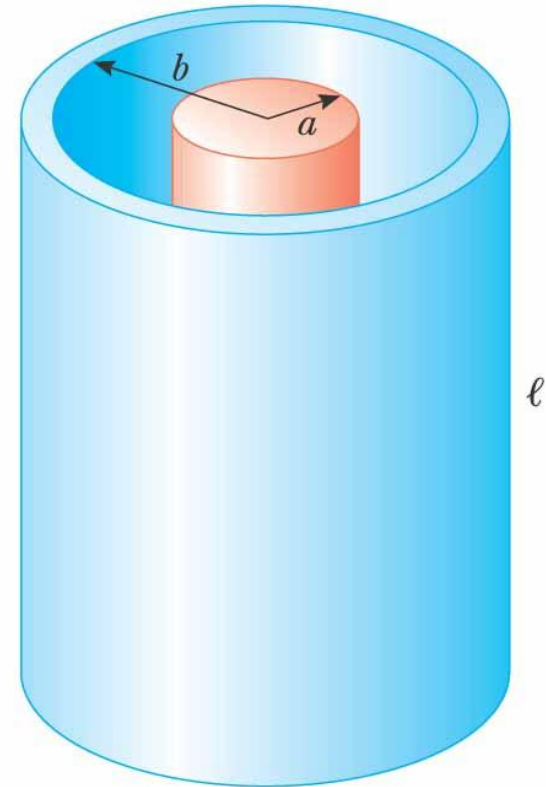

(a)

Capacitance of a Spherical Capacitor



- The potential difference will be

$$\Delta V = k_e Q \left(\frac{1}{b} - \frac{1}{a} \right)$$

- The capacitance will be

$$C = \frac{Q}{\Delta V} = \frac{ab}{k_e (b - a)}$$

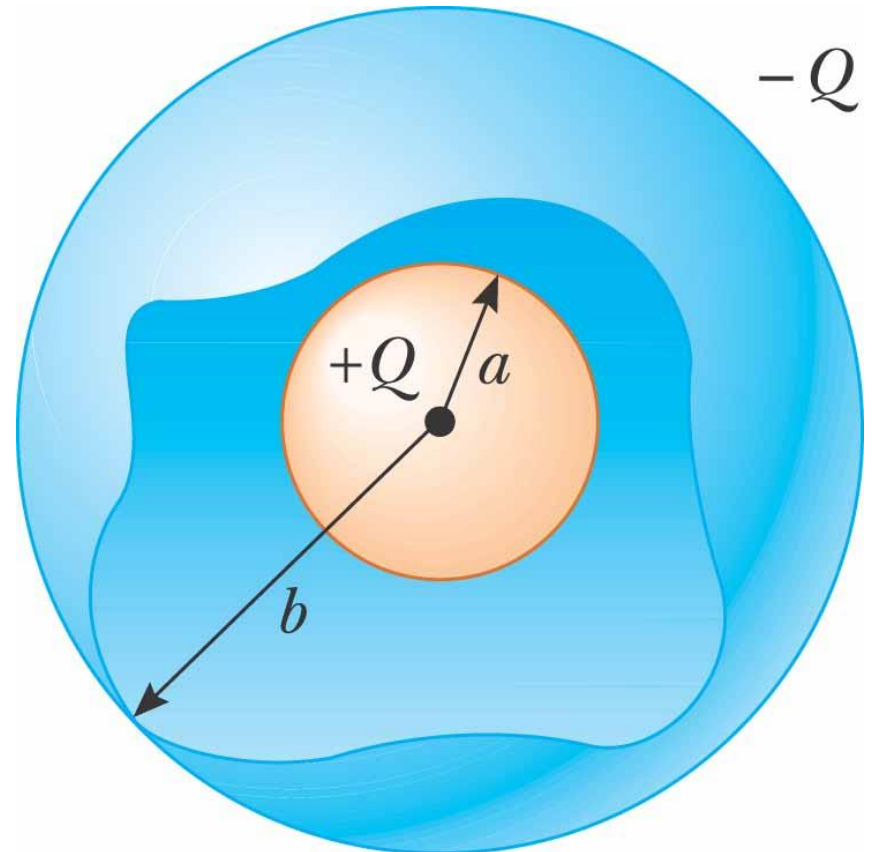

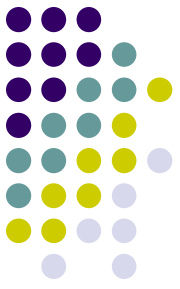

Circuit Symbols

- A circuit diagram is a simplified representation of an actual circuit
- Circuit symbols are used to represent the various elements
- Lines are used to represent wires
- The battery's positive terminal is indicated by the longer line

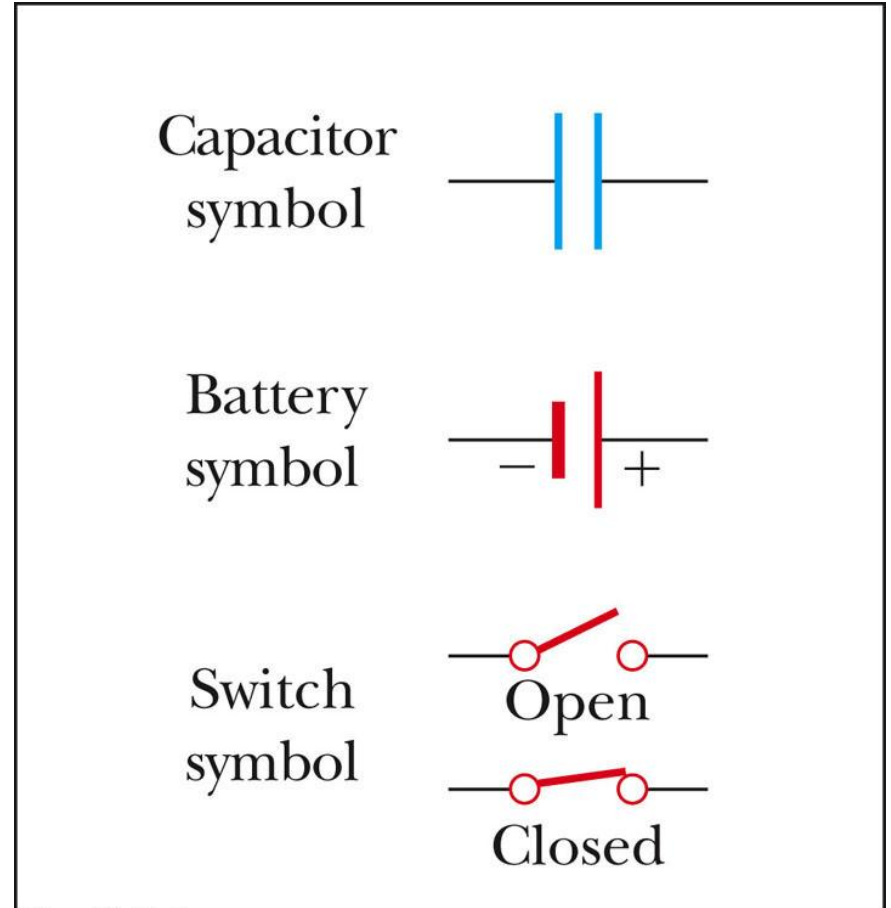

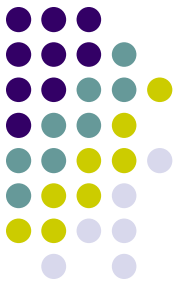

Capacitors in Parallel

- When capacitors are first connected in the circuit, electrons are transferred from the left plates through the battery to the right plate, leaving the left plate positively charged and the right plate negatively charged

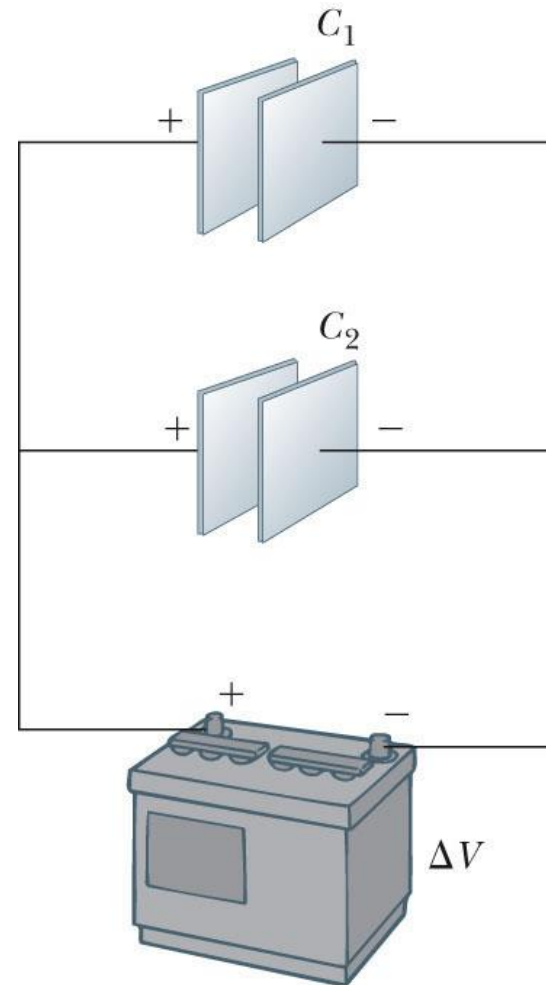

(a)



Capacitors in Parallel, 2

- The flow of charges ceases when the voltage across the capacitors equals that of the battery
- The potential difference across the capacitors is the same
 - And each is equal to the voltage of the battery
 - $\Delta V_1 = \Delta V_2 = \Delta V$
 - ΔV is the battery terminal voltage
- The capacitors reach their maximum charge when the flow of charge ceases
- The total charge is equal to the sum of the charges on the capacitors
 - $Q_{\text{total}} = Q_1 + Q_2$

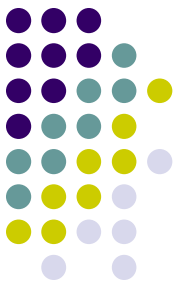

Capacitors in Parallel, 3

- The capacitors can be replaced with one capacitor with a capacitance of C_{eq}
 - The *equivalent capacitor* must have exactly the same external effect on the circuit as the original capacitors

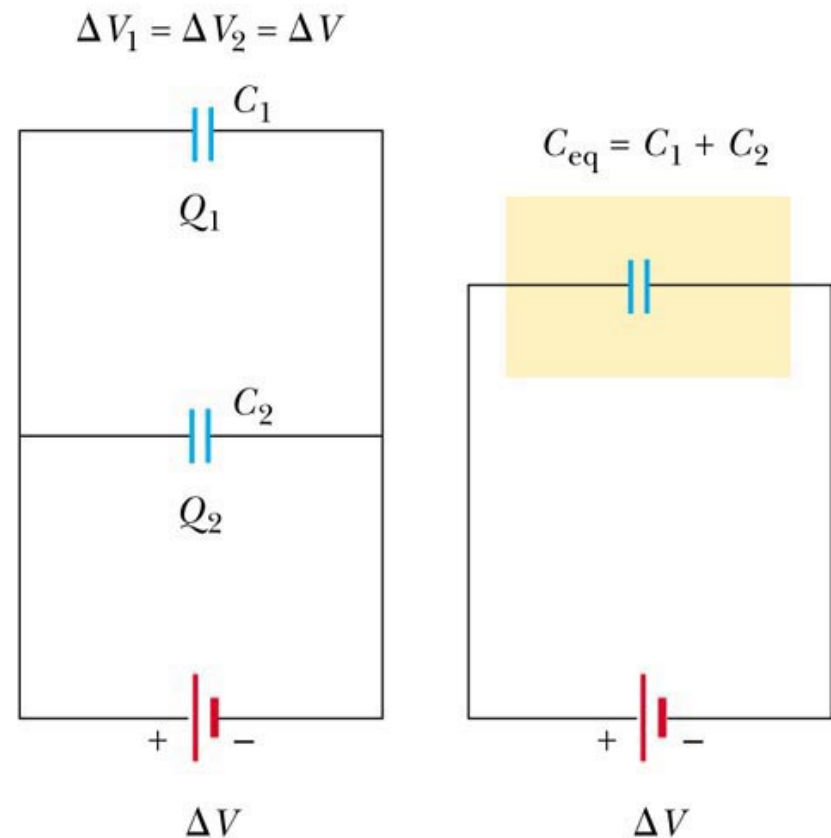

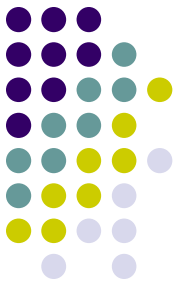

Capacitors in Parallel, final

- $C_{\text{eq}} = C_1 + C_2 + C_3 + \dots$
- The equivalent capacitance of a parallel combination of capacitors is greater than any of the individual capacitors
 - Essentially, the areas are combined
- Use the active figure to vary the battery potential and the various capacitors and observe the resulting charges and voltages on the capacitors

Capacitors in Series



- When a battery is connected to the circuit, electrons are transferred from the left plate of C_1 to the right plate of C_2 through the battery

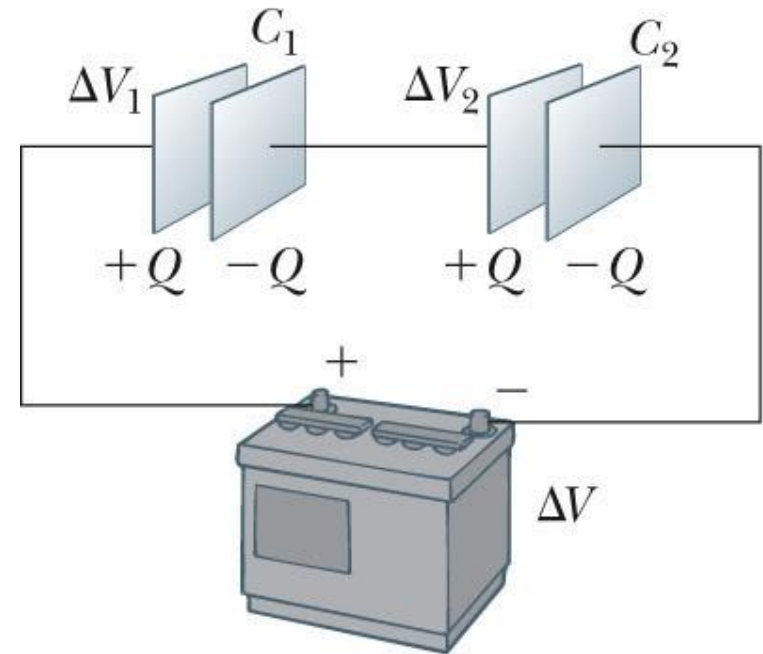

(a)

© Thomson Higher Education

PLAY
ACTIVE FIGURE

Capacitors in Series, 2

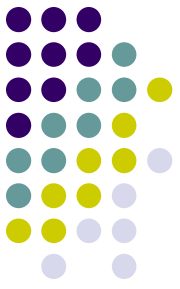

- As this negative charge accumulates on the right plate of C_2 , an equivalent amount of negative charge is removed from the left plate of C_2 , leaving it with an excess positive charge
- All of the right plates gain charges of $-Q$ and all the left plates have charges of $+Q$

Capacitors in Series, 3



- An equivalent capacitor can be found that performs the same function as the series combination
- The charges are all the same

$$Q_1 = Q_2 = Q$$

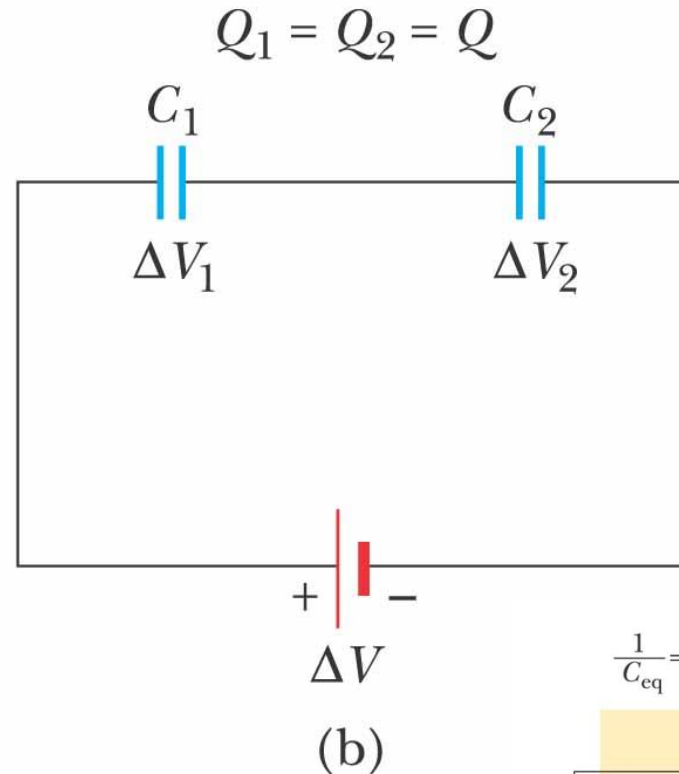

©2004 Thomson - Brooks/Cole

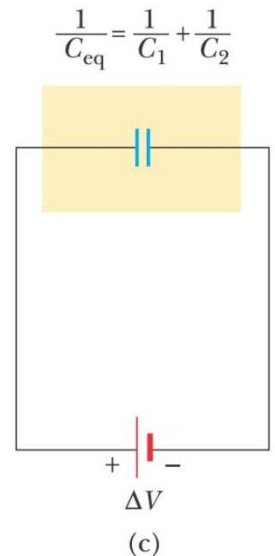

©2004 Thomson - Brooks/Cole

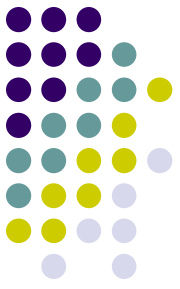

Capacitors in Series, final

- The potential differences add up to the battery voltage

$$\Delta V_{\text{tot}} = \Delta V_1 + \Delta V_2 + \dots$$

- The equivalent capacitance is

$$\frac{1}{C_{eq}} = \frac{1}{C_1} + \frac{1}{C_2} + \frac{1}{C_3} + \dots$$

- The equivalent capacitance of a series combination is always less than any individual capacitor in the combination

Equivalent Capacitance, Example

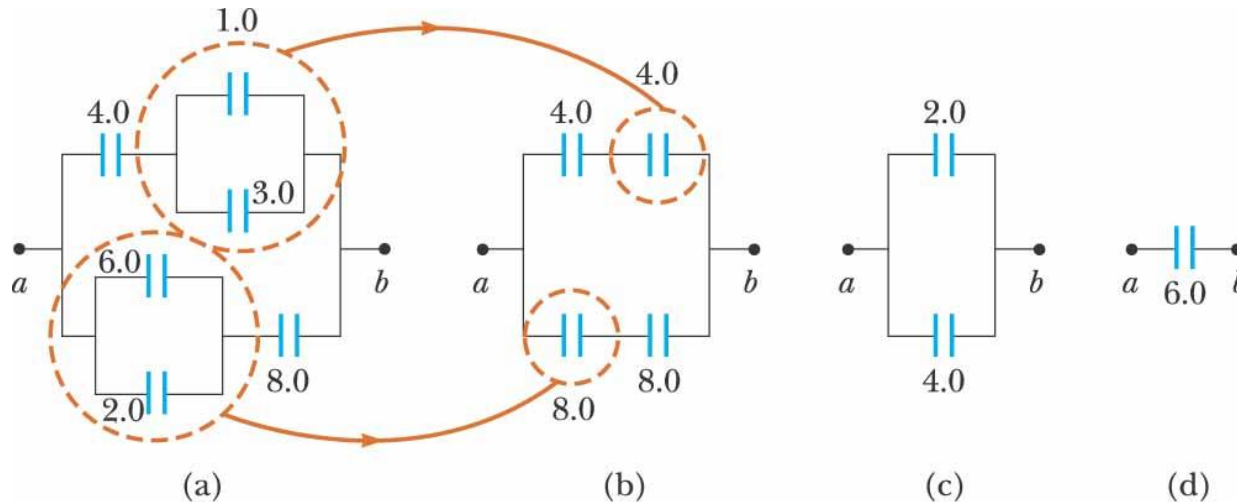

©2004 Thomson - Brooks/Cole

- The 1.0- μF and 3.0- μF capacitors are in parallel as are the 6.0- μF and 2.0- μF capacitors
- These parallel combinations are in series with the capacitors next to them
- The series combinations are in parallel and the final equivalent capacitance can be found

Energy in a Capacitor – Overview



- Consider the circuit to be a system
- Before the switch is closed, the energy is stored as chemical energy in the battery
- When the switch is closed, the energy is transformed from chemical to electric potential energy

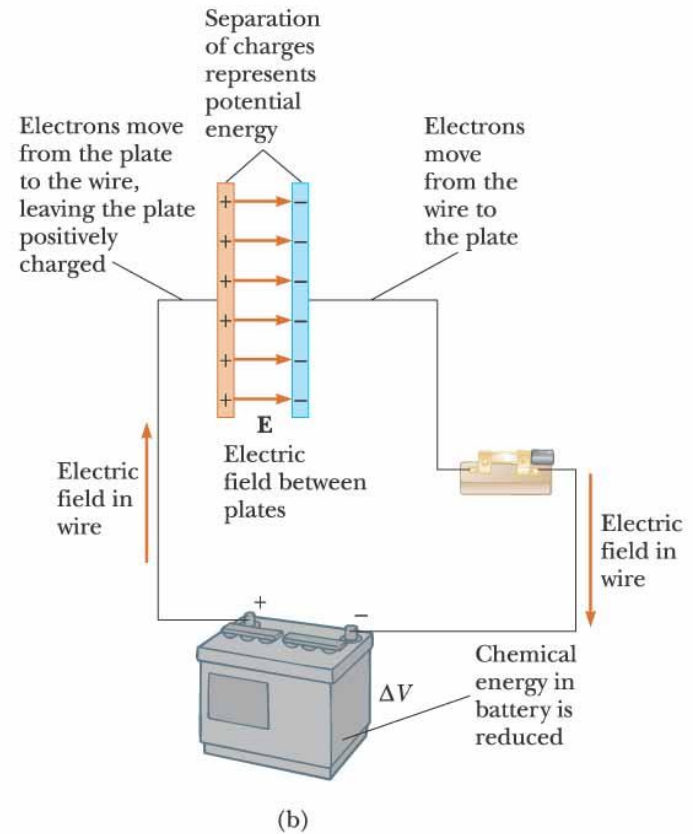

Energy in a Capacitor – Overview, cont

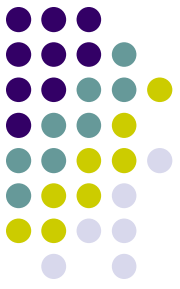

- The electric potential energy is related to the separation of the positive and negative charges on the plates
- **A capacitor** can be described as a device that stores energy as well as charge

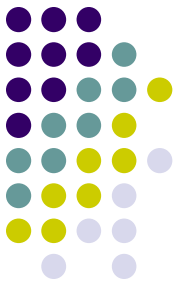

Energy Stored in a Capacitor

- Assume the capacitor is being charged and, at some point, has a charge q on it
- The work needed to transfer a charge from one plate to the other is

$$dW = \Delta V dq = \frac{q}{C} dq$$

- The total work required is

$$W = \int_0^Q \frac{q}{C} dq = \frac{Q^2}{2C}$$

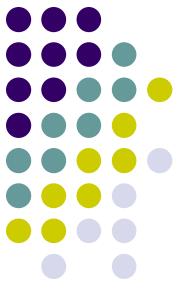

Energy, cont

- The work done in charging the capacitor appears as electric potential energy U :

$$U = \frac{Q^2}{2C} = \frac{1}{2} Q\Delta V = \frac{1}{2} C(\Delta V)^2$$

- This applies to a capacitor of any geometry
- The energy stored increases as the charge increases and as the potential difference increases
- In practice, there is a maximum voltage before discharge occurs between the plates

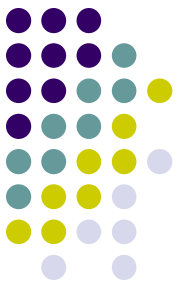

Energy, final

- The energy can be considered to be stored in the electric field
- For a **parallel-plate capacitor**, the energy can be expressed in terms of the field as $U = \frac{1}{2} (\epsilon_0 Ad) E^2$
- It can also be expressed in terms of the **energy density** (energy per unit volume)

$$u_E = \frac{1}{2} \epsilon_0 E^2$$

Some Uses of Capacitors



- Defibrillators
 - When cardiac fibrillation occurs, the heart produces a rapid, irregular pattern of beats
 - A fast discharge of electrical energy through the heart can return the organ to its normal beat pattern
- In general, capacitors act as energy reservoirs that can be slowly charged and then discharged quickly to provide large amounts of energy in a short pulse

Capacitors with Dielectrics



- A **dielectric** is a **nonconducting material** that, when placed between the plates of a capacitor, **increases the capacitance**
 - Dielectrics include rubber, glass, and waxed paper
- With a dielectric, the capacitance becomes $C = \kappa C_0$
 - The **capacitance increases by the factor κ** when the dielectric completely fills the region between the plates
 - κ is the **dielectric constant** of the material

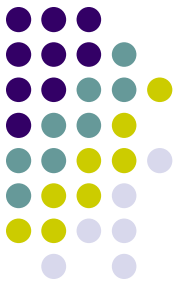

Dielectrics, cont

- For a parallel-plate capacitor, $C = \kappa\epsilon_0(A/d)$
- In theory, d could be made very small to create a very large capacitance
- In practice, there is a limit to d
 - d is limited by the electric discharge that could occur through the dielectric medium separating the plates
- For a given d , the maximum voltage that can be applied to a capacitor without causing a discharge depends on the **dielectric strength** of the material



Dielectrics, final

- Dielectrics provide the following advantages:
 - Increase in capacitance
 - Increase the maximum operating voltage
 - Possible mechanical support between the plates
 - This allows the plates to be close together without touching
 - This decreases d and increases C

TABLE 26.1**Approximate Dielectric Constants and Dielectric Strengths of Various Materials at Room Temperature**

Material	Dielectric Constant κ	Dielectric Strength ^a (10^6 V/m)
Air (dry)	1.000 59	3
Bakelite	4.9	24
Fused quartz	3.78	8
Mylar	3.2	7
Neoprene rubber	6.7	12
Nylon	3.4	14
Paper	3.7	16
Paraffin-impregnated paper	3.5	11
Polystyrene	2.56	24
Polyvinyl chloride	3.4	40
Porcelain	6	12
Pyrex glass	5.6	14
Silicone oil	2.5	15
Strontium titanate	233	8
Teflon	2.1	60
Vacuum	1.000 00	—
Water	80	—

^a The dielectric strength equals the maximum electric field that can exist in a dielectric without electrical breakdown. These values depend strongly on the presence of impurities and flaws in the materials.



Types of Capacitors – Tubular

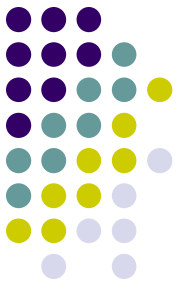

- Metallic foil may be interlaced with thin sheets of paraffin-impregnated paper or Mylar
- The layers are rolled into a **cylinder** to form a small package for the capacitor

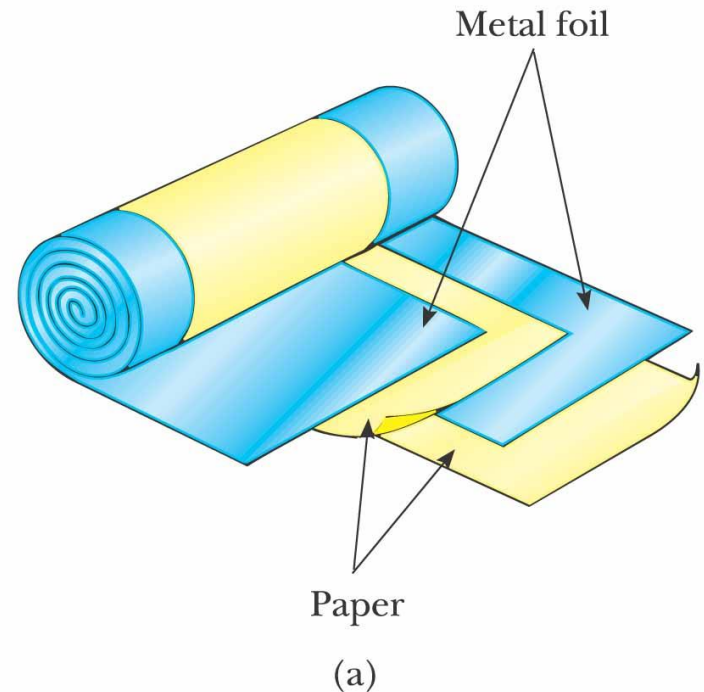

Types of Capacitors – Oil Filled



- Common for high-voltage capacitors
- A number of interwoven metallic plates are immersed in silicon oil

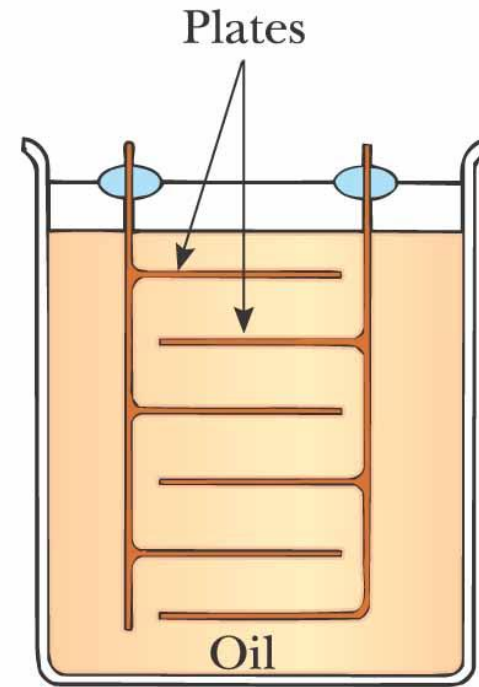

(b)

Types of Capacitors – Electrolytic

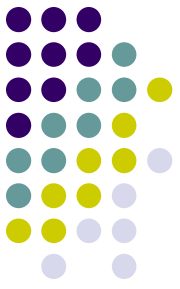

- Used to store large amounts of charge at relatively low voltages
- The electrolyte is a solution that conducts electricity by virtue of motion of ions contained in the solution

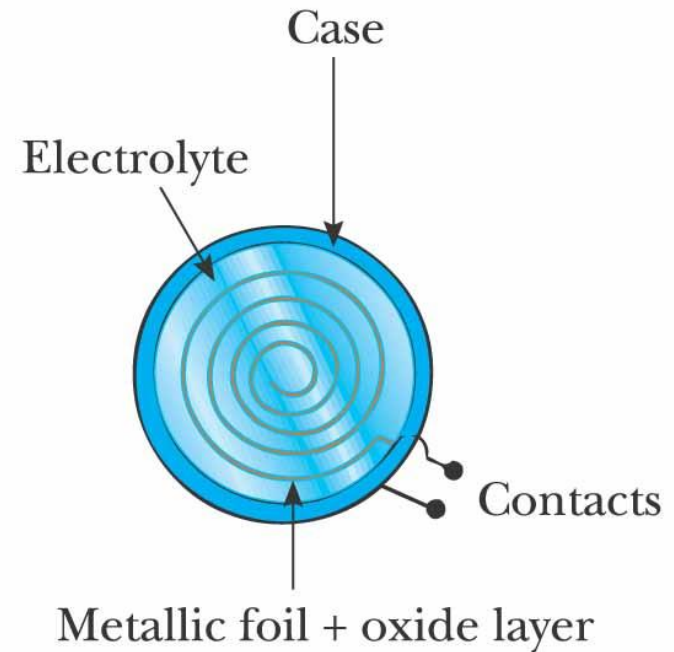

(c)

Types of Capacitors – Variable



- Variable capacitors consist of two interwoven sets of metallic plates
- One plate is fixed and the other is movable
- These capacitors generally vary between 10 and 500 pF
- Used in radio tuning circuits



© 2004 Thomson - Brooks/Cole

Electric Dipole

- An electric dipole consists of two charges of equal magnitude and opposite signs
- The charges are separated by $2a$
- The **electric dipole moment** (\vec{p}) is directed along the line joining the charges from $-q$ to $+q$

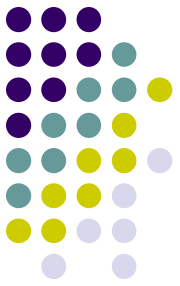
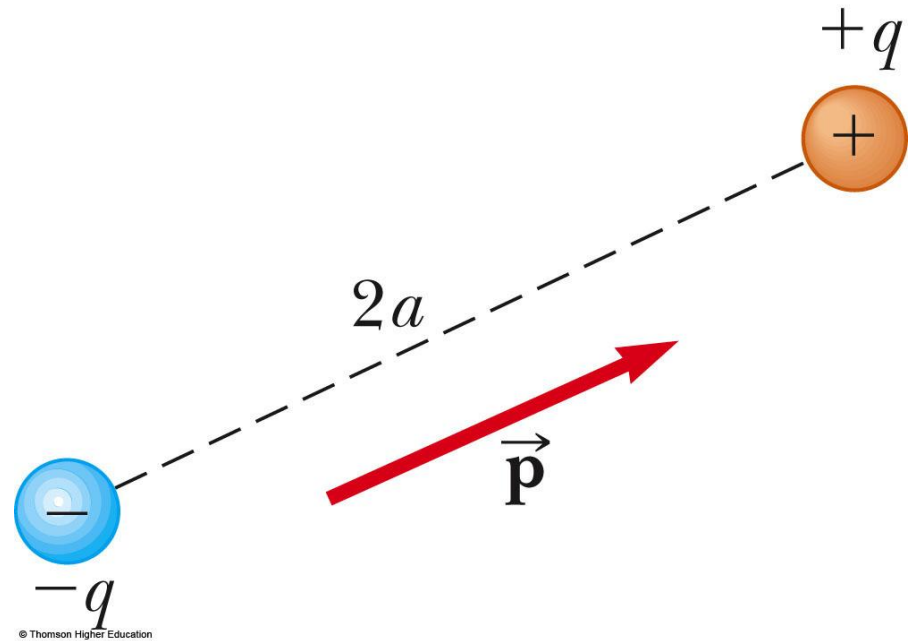

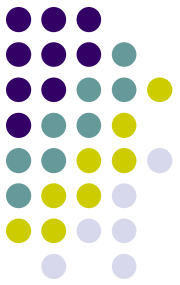

Electric Dipole, 2

- The electric dipole moment has a magnitude of $p \equiv 2aq$
- Assume the dipole is placed in a uniform external field, $\vec{\mathbf{E}}$
 - $\vec{\mathbf{E}}$ is external to the dipole; it is not the field produced by the dipole
- Assume the dipole makes an angle θ with the field

Electric Dipole, 3

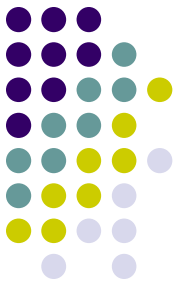

- Each charge has a force of $F = Eq$ acting on it
- The net force on the dipole is zero
- The forces produce a net torque on the dipole

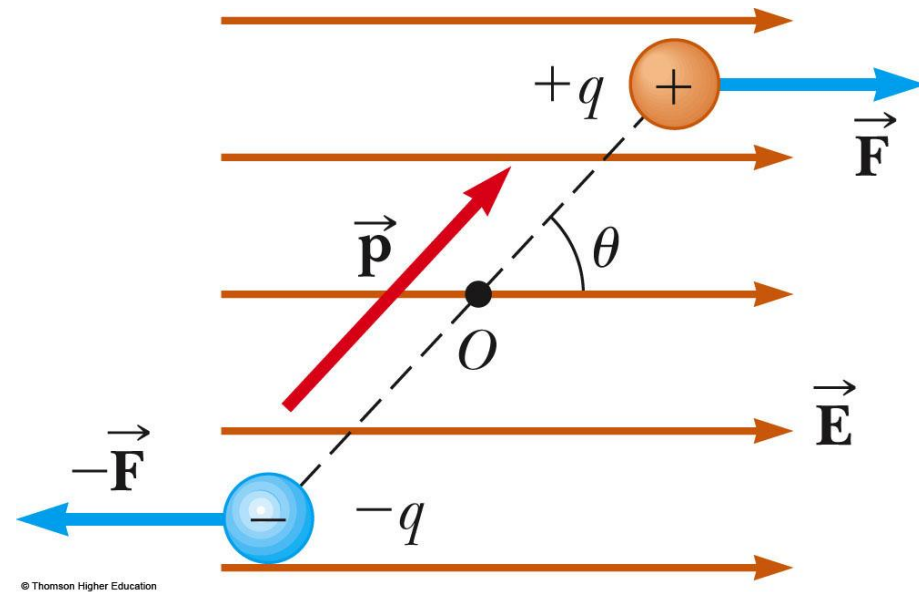

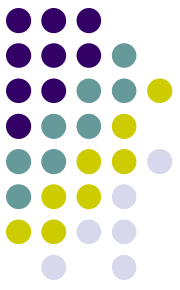

Electric Dipole, final

- The **magnitude of the torque** is:

$$\tau = 2Fa \sin \theta = pE \sin \theta$$

- The torque can also be expressed as the cross product of the moment and the field:

$$\vec{\tau} = \vec{\mathbf{p}} \times \vec{\mathbf{E}}$$

- The **potential energy** can be expressed as a function of the orientation of the dipole with the field:

$$U_f - U_i = pE(\cos \theta_i - \cos \theta_f) \rightarrow$$

$$U = -pE \cos \theta$$

$$U = \vec{\mathbf{p}} \cdot \vec{\mathbf{E}}$$

Polar vs. Nonpolar Molecules

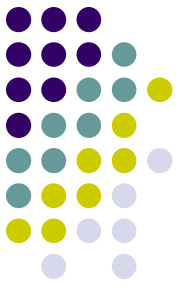

- Molecules are said to be ***polarized*** when a separation exists between the average position of the negative charges and the average position of the positive charges
- **Polar molecules** are those in which this condition is always present
- Molecules without a permanent polarization are called **nonpolar molecules**

Water Molecules



- A water molecule is an example of a polar molecule
- The center of the negative charge is near the center of the oxygen atom
- The x is the center of the positive charge distribution

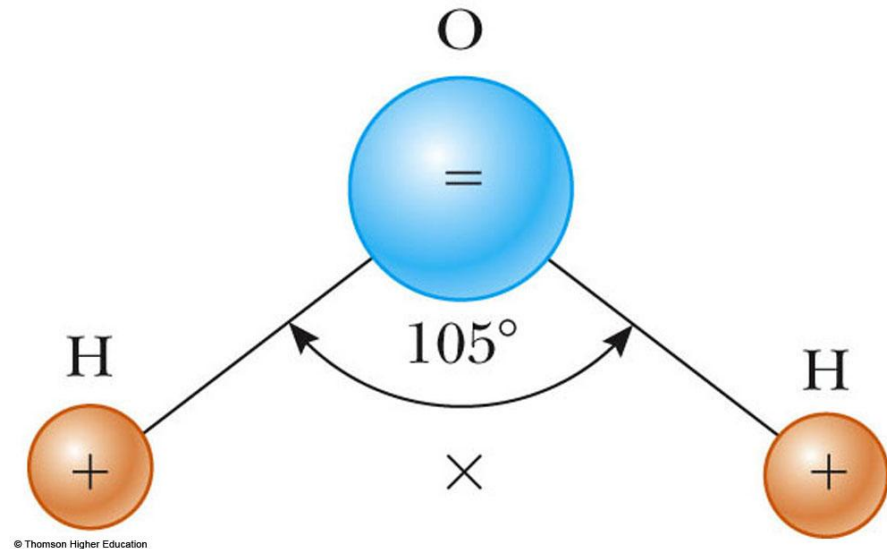

Polar Molecules and Dipoles

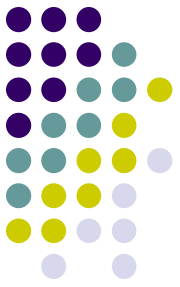

- The average positions of the positive and negative charges act as point charges
- Therefore, polar molecules can be modeled as electric dipoles

Induced Polarization

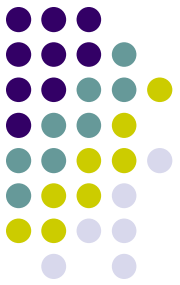

- A linear symmetric molecule has no permanent polarization (a)
- Polarization can be induced by placing the molecule in an electric field (b)
- Induced polarization is the effect that predominates in most materials used as dielectrics in capacitors

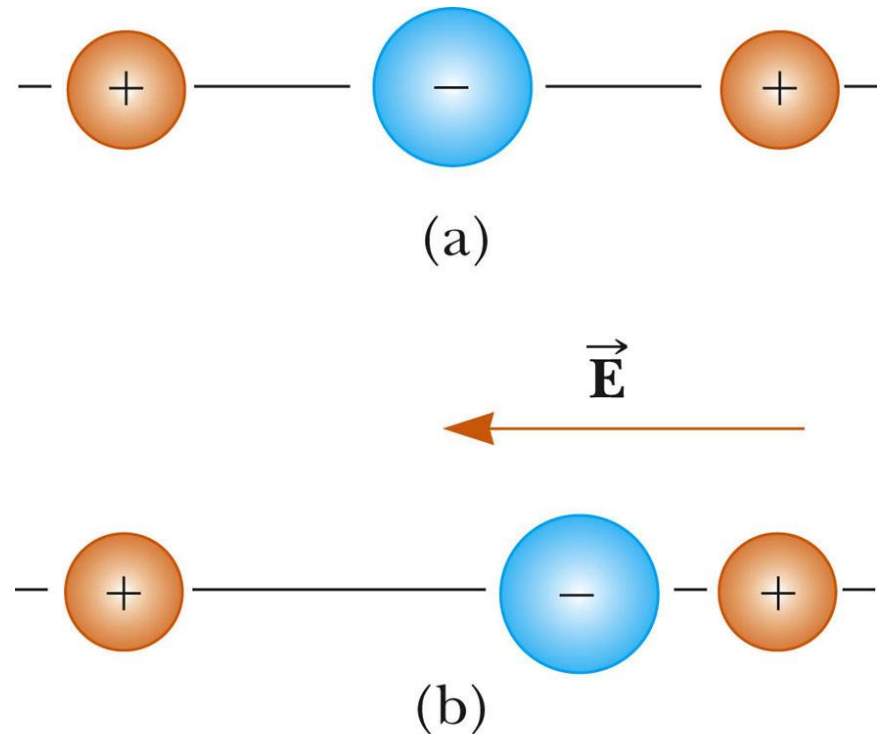

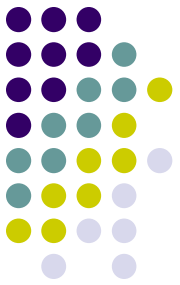

Dielectrics – An Atomic View

- The molecules that make up the dielectric are modeled as dipoles
- The molecules are randomly oriented in the absence of an electric field

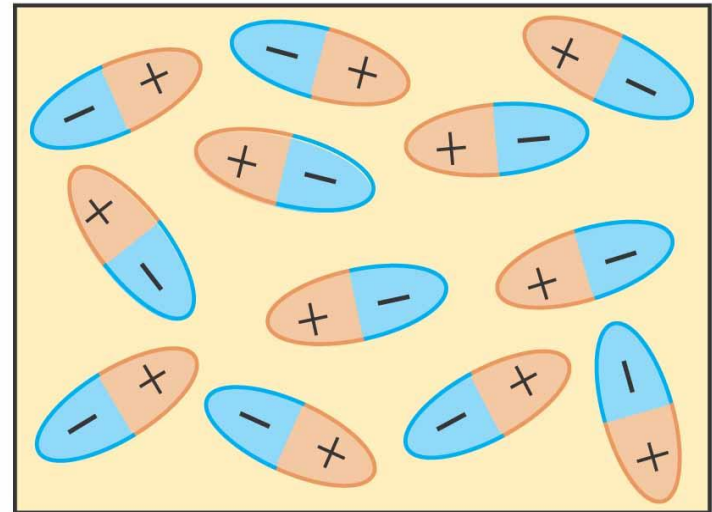

(a)

Dielectrics – An Atomic View, 2

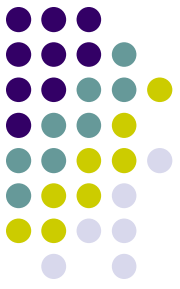

- An external electric field is applied
- This produces a torque on the molecules
- The molecules partially align with the electric field

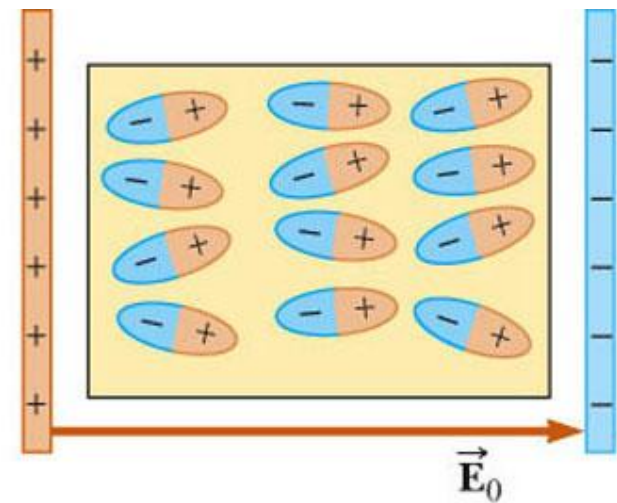

(b)

Dielectrics – An Atomic View,

3

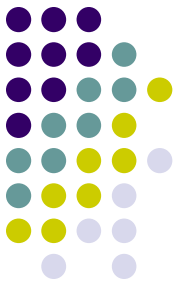

- The degree of alignment of the molecules with the field depends on temperature and the magnitude of the field
- In general,
 - the alignment increases with decreasing temperature
 - the alignment increases with increasing field strength

Dielectrics – An Atomic View, 4

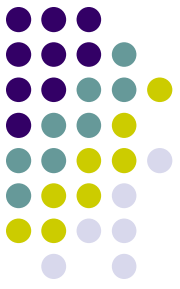

- If the molecules of the dielectric are nonpolar molecules, the electric field produces some charge separation
- This produces an *induced dipole moment*
- The effect is then the same as if the molecules were polar

Dielectrics – An Atomic View, final



- An external field can polarize the dielectric whether the molecules are polar or nonpolar
- The charged edges of the dielectric act as a second pair of plates producing an induced electric field in the direction opposite the original electric field

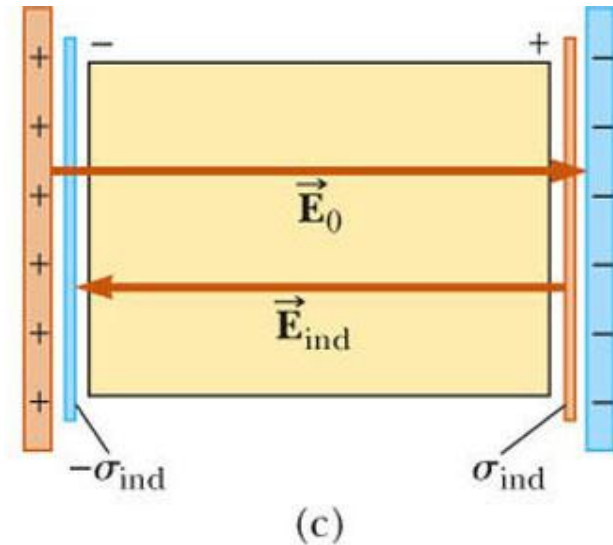

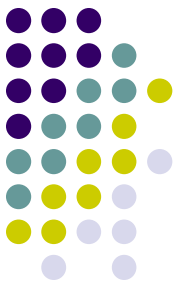

Induced Charge and Field

- The electric field due to the plates is directed to the right and it polarizes the dielectric
- The net effect on the dielectric is an induced surface charge that results in an induced electric field
- If the dielectric were replaced with a conductor, the net field between the plates would be zero

