

Chapter 31

Faraday's Law



Michael Faraday

- 1791 – 1867
- British physicist and chemist
- Great experimental scientist
- Contributions to early electricity include:
 - Invention of motor, generator, and transformer
 - Electromagnetic induction
 - Laws of electrolysis



© 2004 Thomson - Brooks/Cole

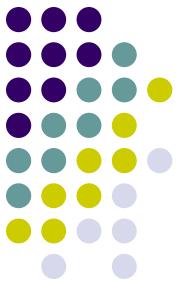



Induction

- An *induced current* is produced by a changing magnetic field
- There is an *induced emf* associated with the induced current
- A current can be produced without a battery present in the circuit
- Faraday's law of induction describes the induced emf

EMF Produced by a Changing Magnetic Field, 1

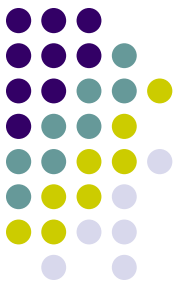

- A loop of wire is connected to a sensitive ammeter
- When a magnet is moved toward the loop, the ammeter deflects
 - The direction was arbitrarily chosen to be negative

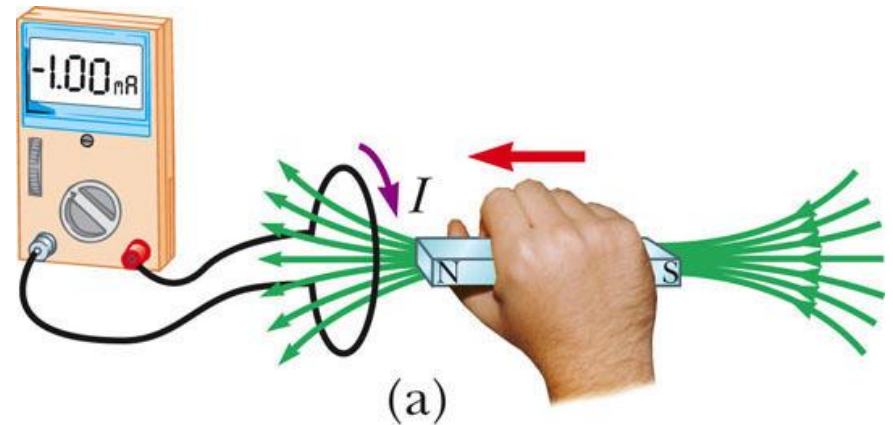

PLAY
ACTIVE FIGURE

EMF Produced by a Changing Magnetic Field, 2



- When the magnet is held stationary, there is no deflection of the ammeter
- Therefore, there is no induced current
 - Even though the magnet is in the loop

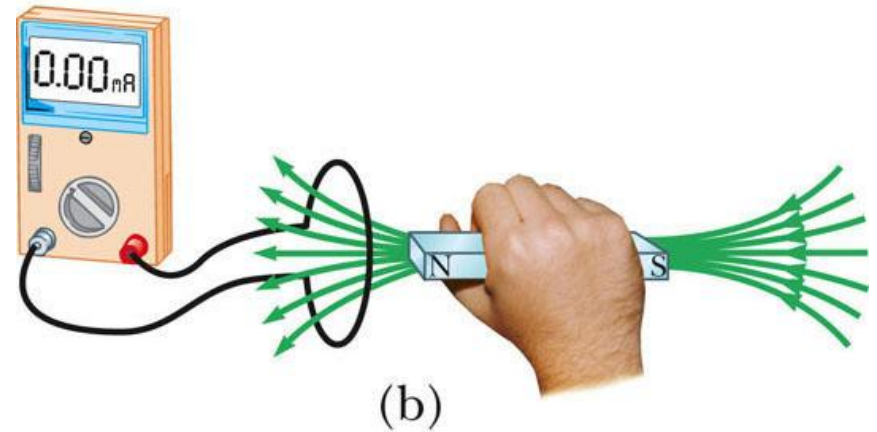

**PLAY
ACTIVE FIGURE**

EMF Produced by a Changing Magnetic Field, 3

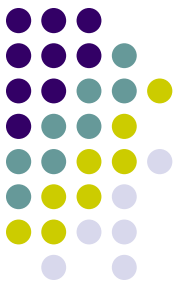

- The magnet is moved away from the loop
- The ammeter deflects in the opposite direction
- Use the active figure to move the wires and observe the deflection on the meter

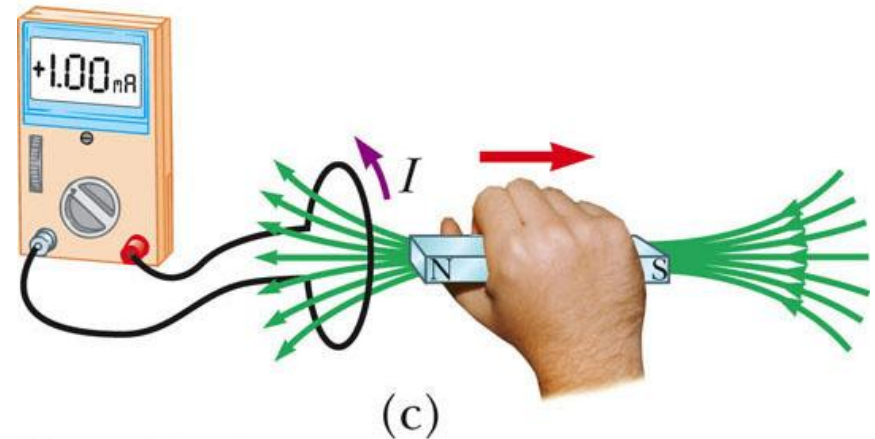

PLAY
ACTIVE FIGURE

Active Figure 31.1

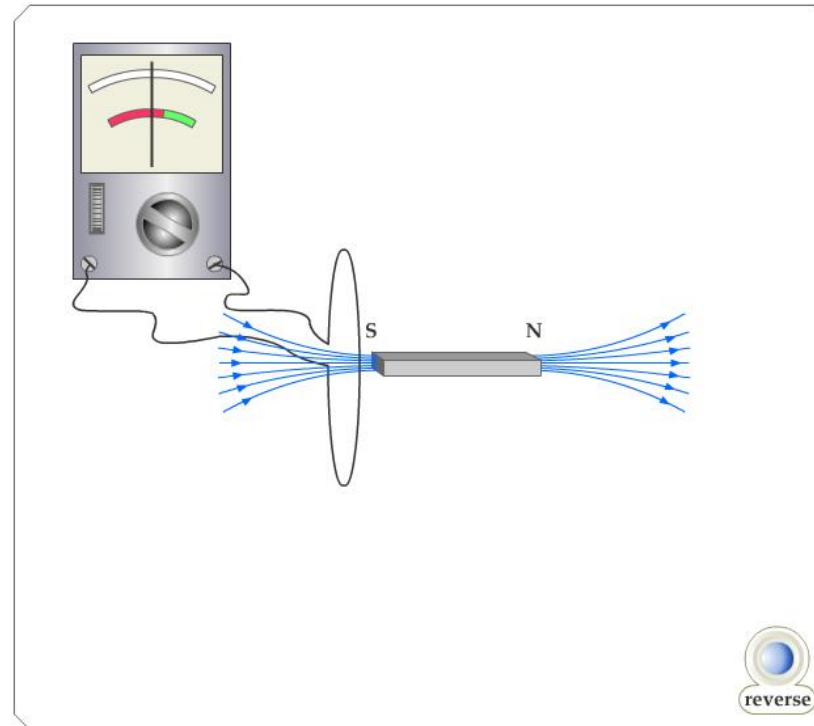

**PLAY
ACTIVE FIGURE**

EMF Produced by a Changing Magnetic Field, Summary

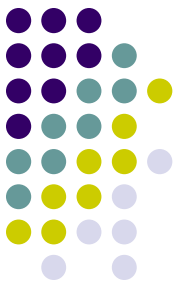

- The ammeter deflects when the magnet is moving toward or away from the loop
- The ammeter also deflects when the loop is moved toward or away from the magnet
- Therefore, the loop detects that the magnet is moving relative to it
 - We relate this detection to a change in the magnetic field
 - This is the induced current that is produced by an induced emf

Faraday's Experiment – Set Up



- A primary coil is connected to a switch and a battery
- The wire is wrapped around an iron ring
- A secondary coil is also wrapped around the iron ring
- **There is no battery present in the secondary coil**
- The secondary coil **is not directly connected to the primary coil**

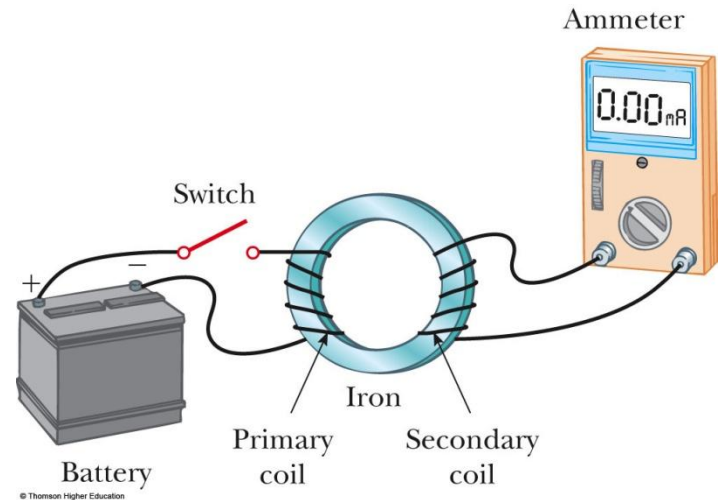

**PLAY
ACTIVE FIGURE**

Active Figure 31.2



- Close the switch and observe the current readings given by the ammeter

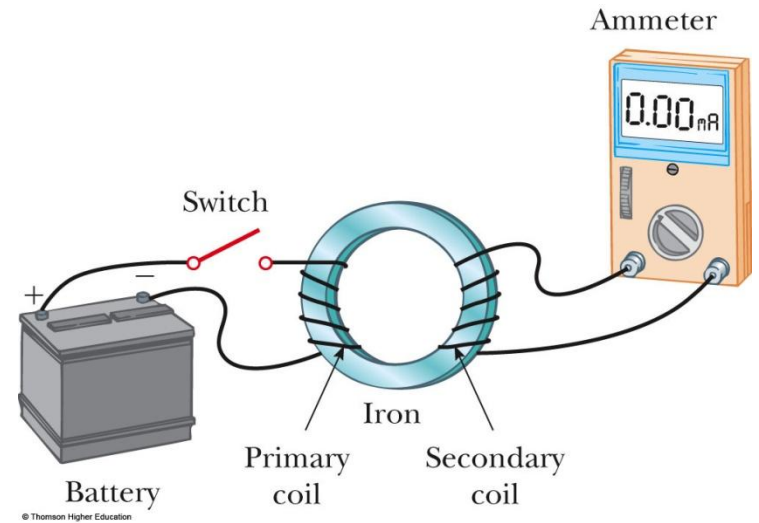

**PLAY
ACTIVE FIGURE**

Faraday's Experiment – Findings



- At the instant the switch is closed, the ammeter changes from zero in one direction and then returns to zero
- When the switch is opened, the ammeter changes in the opposite direction and then returns to zero
- The ammeter reads zero when there is a steady current or when there is no current in the primary circuit

Faraday's Experiment – Conclusions



- An electric current can be induced in a loop by a changing magnetic field
 - This would be the current in the secondary circuit of this experimental set-up
- The **induced current exists only** while the magnetic field through the loop **is changing**
- This is generally expressed as: ***an induced emf is produced in the loop by the changing magnetic field***
 - The actual existence of the magnetic flux is not sufficient to produce the induced emf, **the flux must be changing**



Faraday's Law – Statements

- **Faraday's law** of induction states that “the emf induced in a circuit is directly proportional to the time rate of change of the magnetic flux through the circuit”
- Mathematically,

$$\varepsilon = -\frac{d\Phi_B}{dt}$$

Faraday's Law – Statements, cont



- Remember Φ_B is the magnetic flux through the circuit and is found by

$$\Phi_B = \int \vec{\mathbf{B}} \cdot d\vec{\mathbf{A}}$$

- If the circuit consists of N loops, all of the same area, and if Φ_B is the flux through one loop, an emf is induced in every loop and

Faraday's law becomes

$$\varepsilon = -N \frac{d\Phi_B}{dt}$$

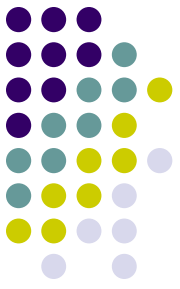

Faraday's Law – Example

- Assume a loop enclosing an area A lies in a uniform magnetic field $\vec{\mathbf{B}}$
- The magnetic flux through the loop is $\Phi_B = BA \cos \theta$
- The induced emf is $\varepsilon = - d/dt (BA \cos \theta)$

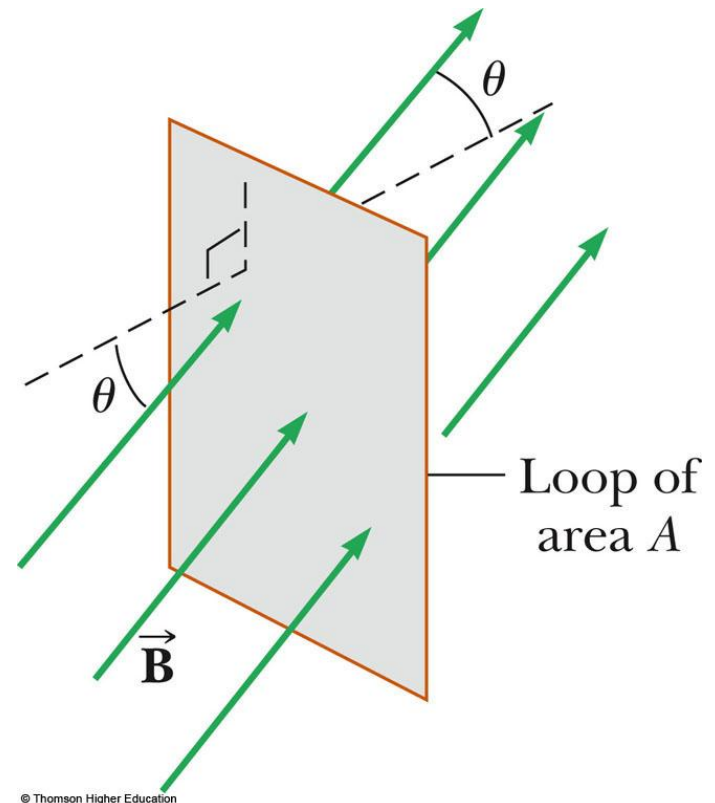



Ways of Inducing an emf

- The **magnitude** of $\vec{\mathbf{B}}$ can change with time
- The **area** enclosed by the loop can change with time
- The **angle** θ between $\vec{\mathbf{B}}$ and the normal to the loop can change with time
- Any combination of the above can occur

Applications of Faraday's Law

– GFI

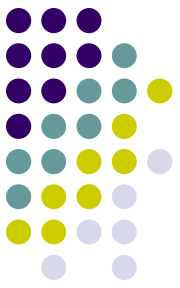

- A GFI (ground fault indicator) protects users of electrical appliances against electric shock
- When the currents in the wires are in opposite directions, the flux is zero
- When the return current in wire 2 changes, the flux is no longer zero
- The resulting induced emf can be used to trigger a circuit breaker

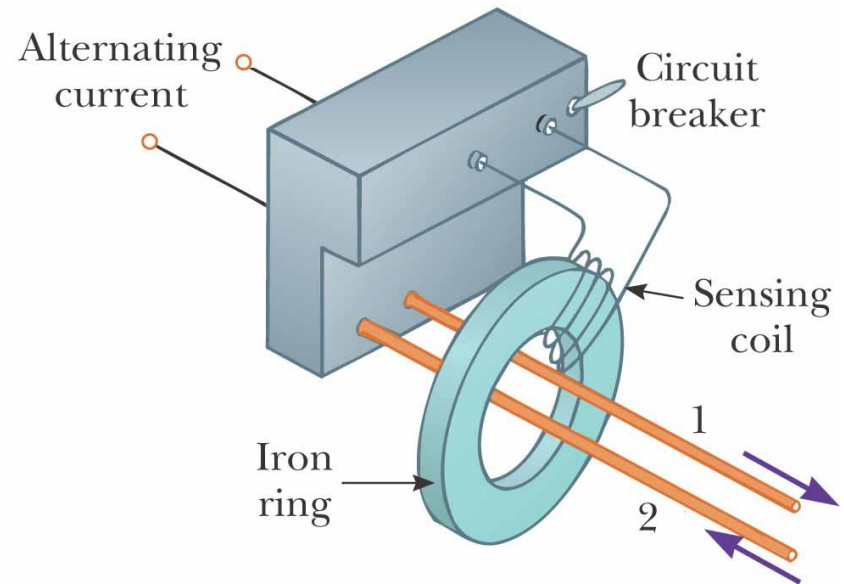

Applications of Faraday's Law

– Pickup Coil



- The pickup coil of an electric guitar uses Faraday's law
- The coil is placed near the vibrating string and causes a portion of the string to become magnetized
- When the string vibrates at some frequency, the magnetized segment produces a changing flux through the coil
- The induced emf is fed to an amplifier

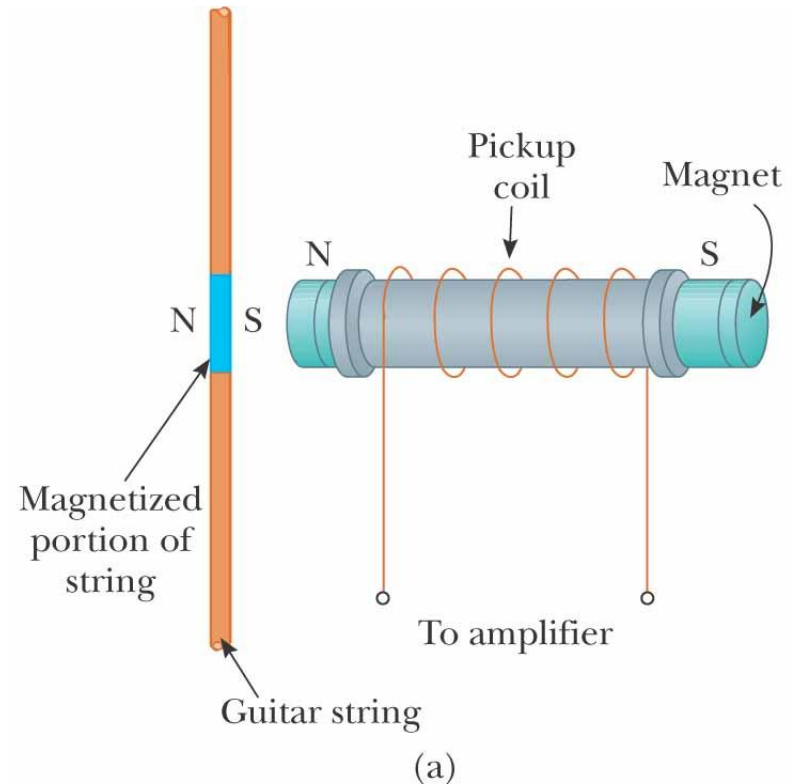

Motional emf

- A **motional emf** is the emf induced in a conductor moving through a constant magnetic field
- The electrons in the conductor experience a force, $\vec{F} = q\vec{v} \times \vec{B}$ that is directed along ℓ

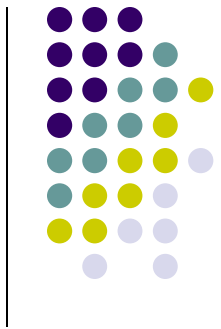
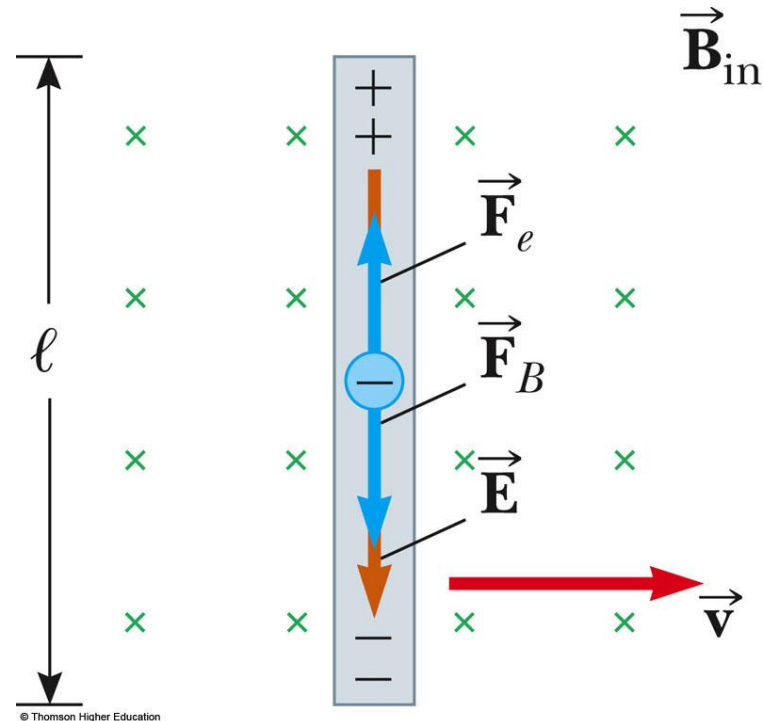



Motional emf, cont.

- Under the influence of the force, the electrons move to the lower end of the conductor and accumulate there
- As a result of the charge separation, an electric field is produced inside the conductor
- The charges accumulate at both ends of the conductor until they are in equilibrium with regard to the electric and magnetic forces

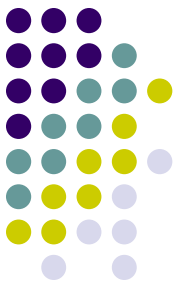

Motional emf, final

- For **equilibrium**, $qE = qvB$ or $E = vB$
- The electric field is related to the potential difference across the ends of the conductor: $DV = E \ell = B \ell v$
- A potential difference is maintained between the ends of the conductor as long as the conductor continues to move through the uniform magnetic field
- If the direction of the motion is reversed, the polarity of the potential difference is also reversed



Sliding Conducting Bar

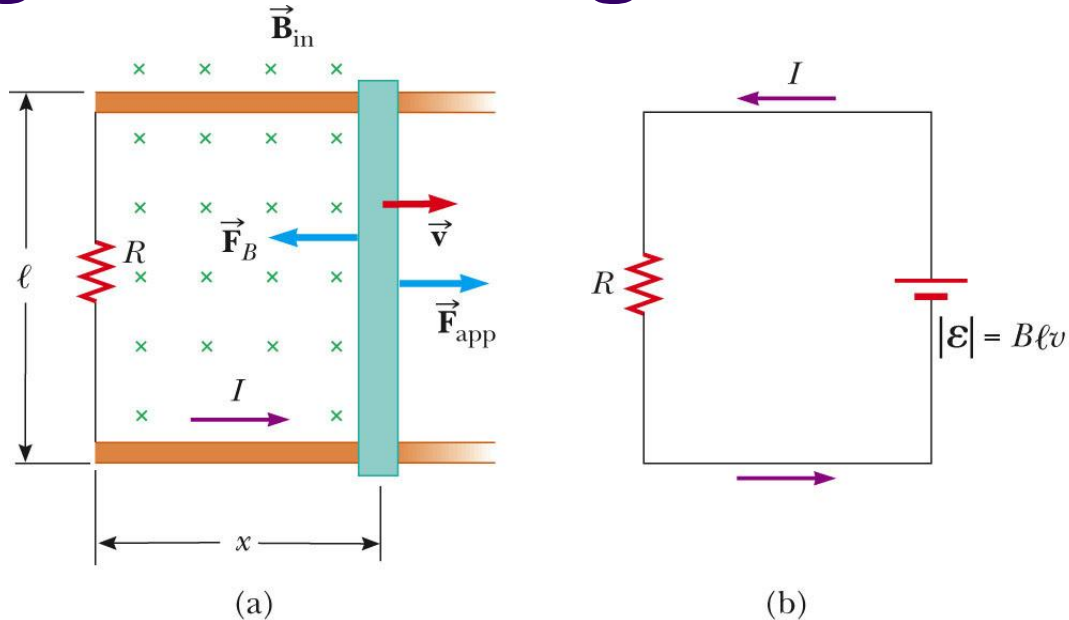

- A bar moving through a uniform field and the equivalent circuit diagram
- Assume the bar has zero resistance
- The stationary part of the circuit has a resistance R

PLAY
ACTIVE FIGURE

Active Figure 31.8

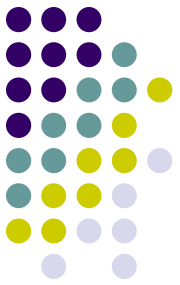

- Use the active figure to adjust the applied force, the electric field and the resistance
- Observe the effects on the motion of the bar

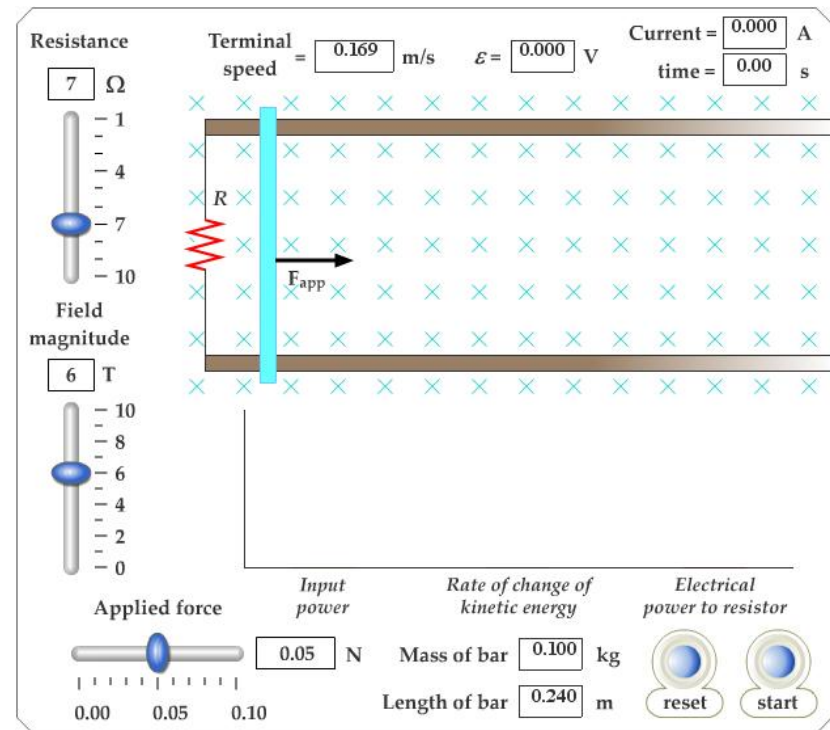

**PLAY
ACTIVE FIGURE**

Sliding Conducting Bar, cont.



- The induced emf is

$$\varepsilon = -\frac{d\Phi_B}{dt} = -Bl\frac{dx}{dt} = -Blv$$

- Since the resistance in the circuit is R , the current is

$$I = \frac{|\varepsilon|}{R} = \frac{Blv}{R}$$

Sliding Conducting Bar, Energy Considerations

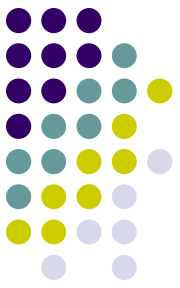

- The applied force does work on the conducting bar
- This moves the charges through a magnetic field and establishes a current
- The change in energy of the system during some time interval must be equal to the transfer of energy into the system by work
- The power input is equal to the rate at which energy is delivered to the resistor

$$\mathcal{P} = F_{\text{app}} v = (I \ell B) v = \frac{\mathcal{E}^2}{R}$$



Lenz's Law

- Faraday's law indicates that the induced emf and the change in flux have opposite algebraic signs
- This has a physical interpretation that has come to be known as Lenz's law
- Developed by German physicist Heinrich Lenz



Lenz's Law, cont.

- **Lenz's law:** *the induced current in a loop is in the direction that creates a magnetic field that opposes the change in magnetic flux through the area enclosed by the loop*
- The induced current tends to keep the original magnetic flux through the circuit from changing

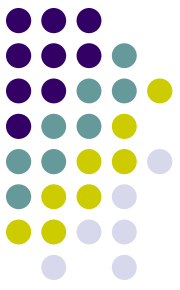

Lenz' Law, Example

- The conducting bar slides on the two fixed conducting rails
- The magnetic flux due to the external magnetic field through the enclosed area increases with time
- The induced current must produce a magnetic field out of the page
 - The induced current must be counterclockwise
- If the bar moves in the opposite direction, the direction of the induced current will also be reversed

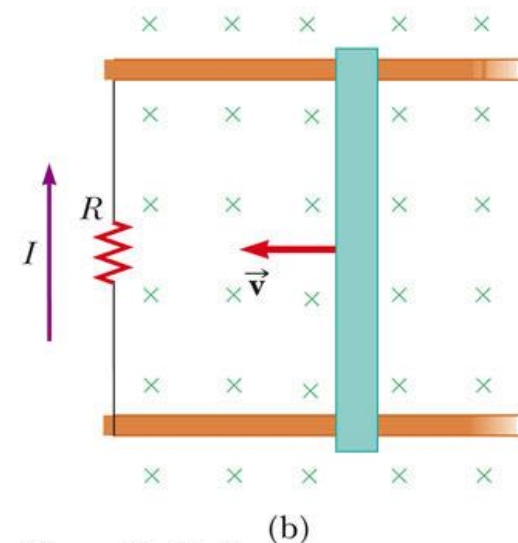
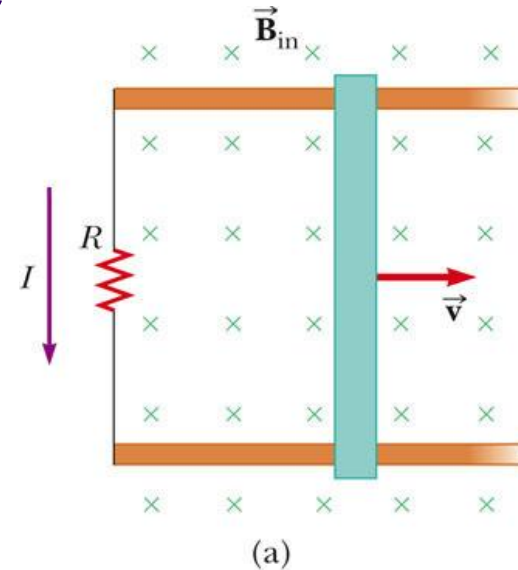

Induced emf and Electric Fields



- An electric field is created in the conductor as a result of the changing magnetic flux
- Even in the absence of a conducting loop, a changing magnetic field will generate an electric field in empty space
- This induced electric field is nonconservative
 - Unlike the electric field produced by stationary charges

Induced emf and Electric Fields, cont.



- The emf for any closed path can be expressed as the line integral of $\vec{\mathbf{E}} \cdot d\vec{\mathbf{s}}$ over the path
- Faraday's law can be written in a general form:

$$\oint \vec{\mathbf{E}} \cdot d\vec{\mathbf{s}} = -\frac{d\Phi_B}{dt}$$

Induced emf and Electric Fields, final



- The induced electric field is a nonconservative field that is generated by a changing magnetic field
- The field cannot be an electrostatic field because if the field were electrostatic, and hence conservative, the line integral of $\vec{E} \cdot d\vec{s}$ would be zero and it isn't

Generators



- Electric generators take in energy by work and transfer it out by electrical transmission
- The AC generator consists of a loop of wire rotated by some external means in a magnetic field
- Use the active figure to adjust the speed of rotation and observe the effect on the emf generated

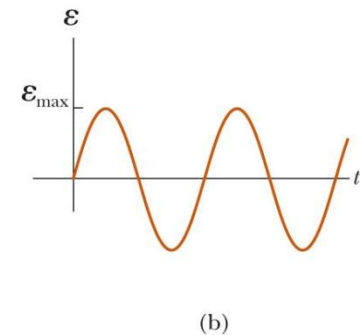
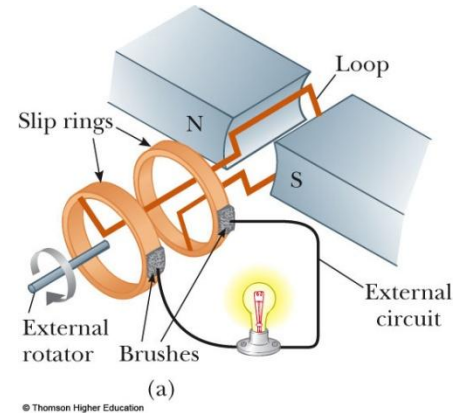

**PLAY
ACTIVE FIGURE**

Rotating Loop

- Assume a loop with N turns, all of the same area rotating in a magnetic field
- The flux through the loop at any time t is $\Phi_B = BA \cos \theta = BA \cos \omega t$

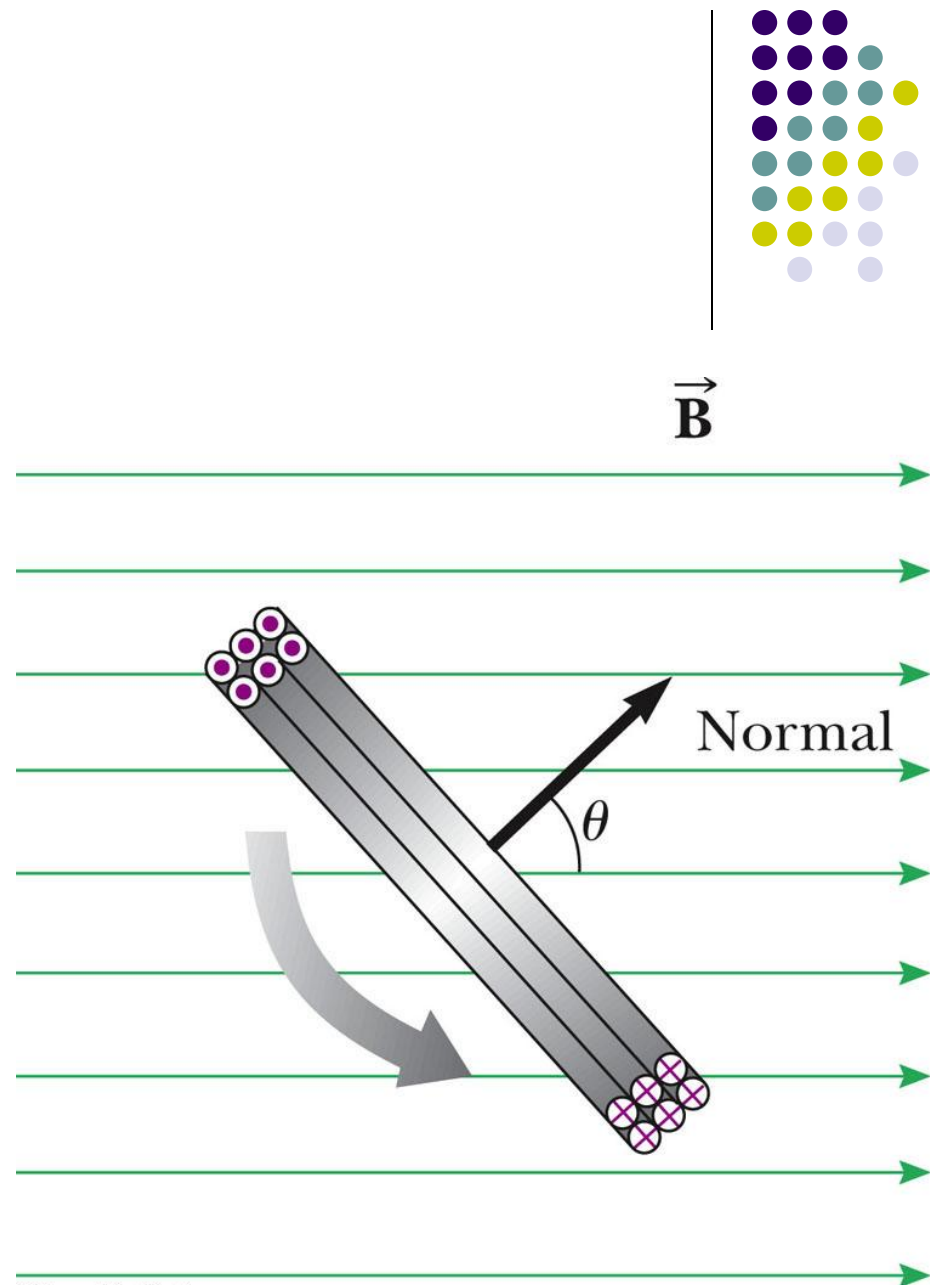

Induced emf in a Rotating Loop



- The induced emf in the loop is

$$\begin{aligned}\varepsilon &= -N \frac{d\Phi_B}{dt} \\ &= NAB\omega \sin \omega t\end{aligned}$$

- This is sinusoidal, with $\varepsilon_{\max} = NAB\omega$

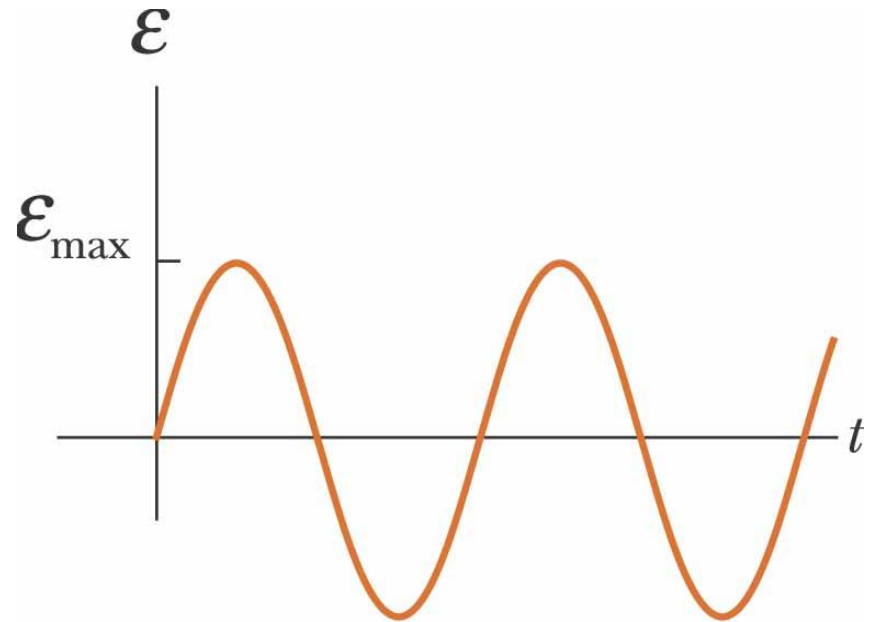

(b)

Induced emf in a Rotating Loop, cont.



- ε_{\max} occurs when $\omega t = 90^\circ$ or 270°
 - This occurs when the magnetic field is in the plane of the coil and the time rate of change of flux is a maximum
- $\varepsilon = 0$ when $\omega t = 0^\circ$ or 180°
 - This occurs when the magnetic field is perpendicular to the plane of the coil and the time rate of change of flux is zero

DC Generators

- The DC (direct current) generator has essentially the same components as the AC generator
- The main difference is that the contacts to the rotating loop are made using a split ring called a *commutator*
- Use the active figure to vary the speed of rotation and observe the effect on the emf generated

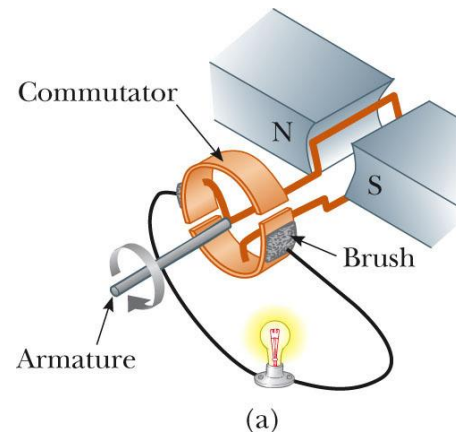

© Thomson Higher Education

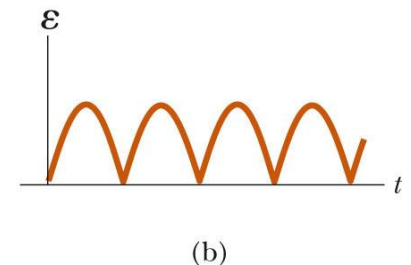

PLAY
ACTIVE FIGURE

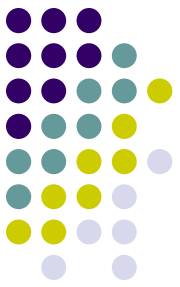

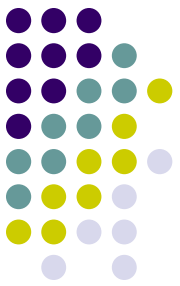

DC Generators, cont.

- In this configuration, the output voltage always has the same polarity
- It also pulsates with time
- To obtain a steady DC current, commercial generators use many coils and commutators distributed so the pulses are out of phase

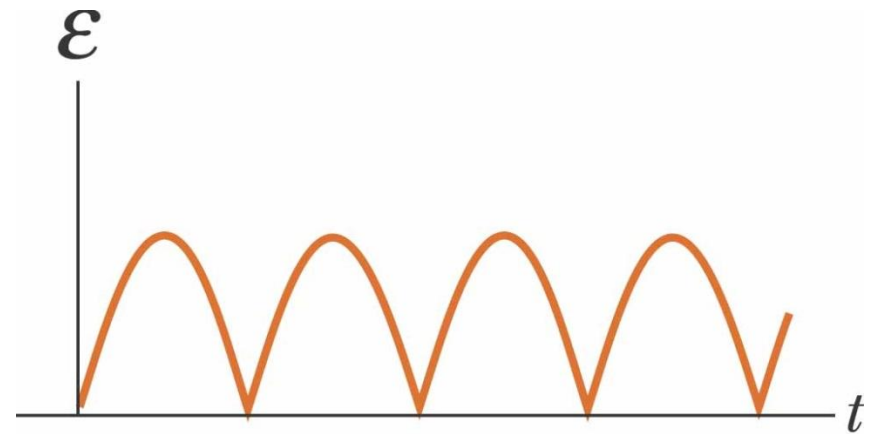

(b)

Motors



- Motors are devices into which energy is transferred by electrical transmission while energy is transferred out by work
- A motor is a generator operating in reverse
- A current is supplied to the coil by a battery and the torque acting on the current-carrying coil causes it to rotate

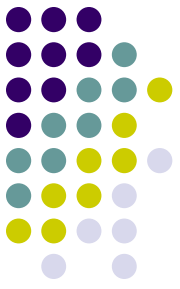

Motors, cont.

- Useful mechanical work can be done by attaching the rotating coil to some external device
- However, as the coil rotates in a magnetic field, an emf is induced
 - This induced emf always acts to reduce the current in the coil
 - The back emf increases in magnitude as the rotational speed of the coil increases



Motors, final

- The current in the rotating coil is limited by the back emf
 - The term *back emf* is commonly used to indicate an emf that tends to reduce the supplied current
- The induced emf explains why the power requirements for starting a motor and for running it are greater for heavy loads than for light ones

Eddy Currents

- Circulating currents called **eddy currents** are induced in bulk pieces of metal moving through a magnetic field
- The eddy currents are in opposite directions as the plate enters or leaves the field
- Eddy currents are often undesirable because they represent a transformation of mechanical energy into internal energy

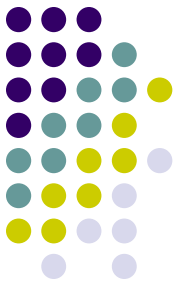
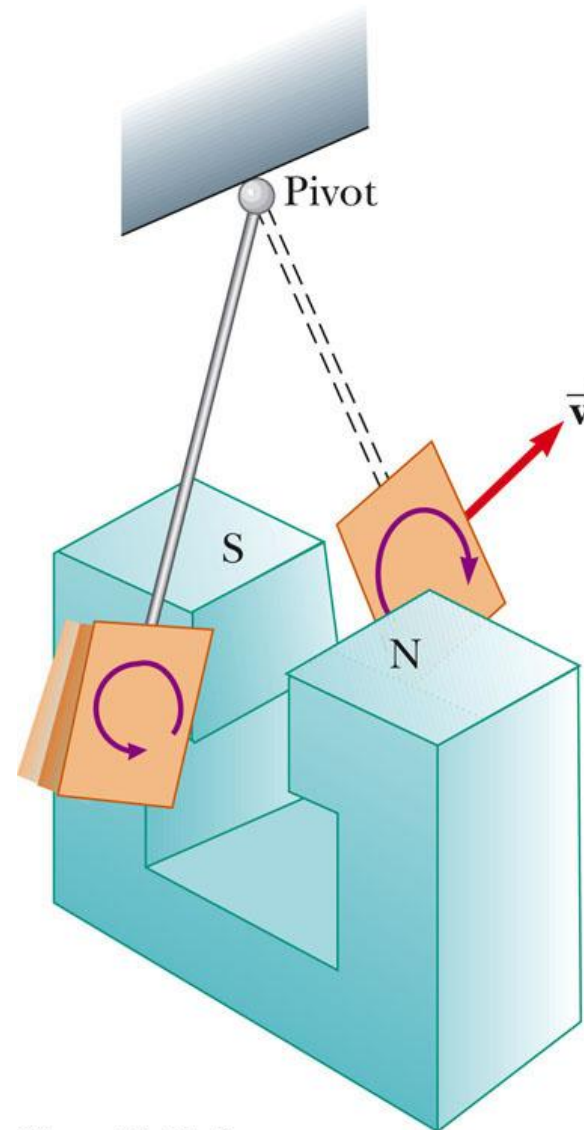



Eddy Currents, Example

- The magnetic field is directed into the page
- The induced eddy current is counterclockwise as the plate enters the field
- It is opposite when the plate leaves the field
- The induced eddy currents produce a magnetic retarding force and the swinging plate eventually comes to rest

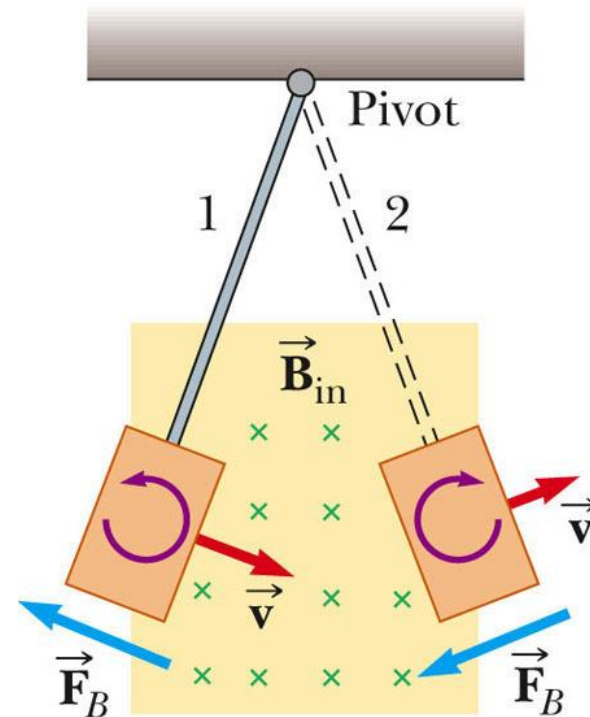

(a)

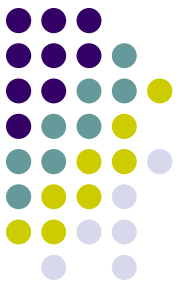

Eddy Currents, Final

- To reduce energy losses by the eddy currents, the conducting parts can
 - Be built up in thin layers separated by a nonconducting material
 - Have slots cut in the conducting plate
- Both prevent large current loops and increase the efficiency of the device

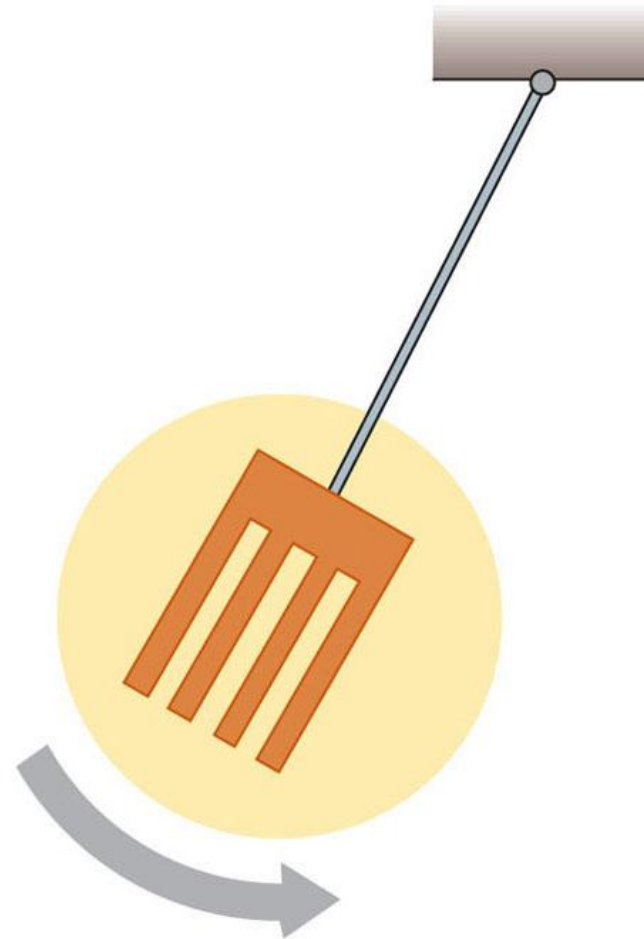

(b)

**PLAY
ACTIVE FIGURE**